

6" Non-Composite Load Table

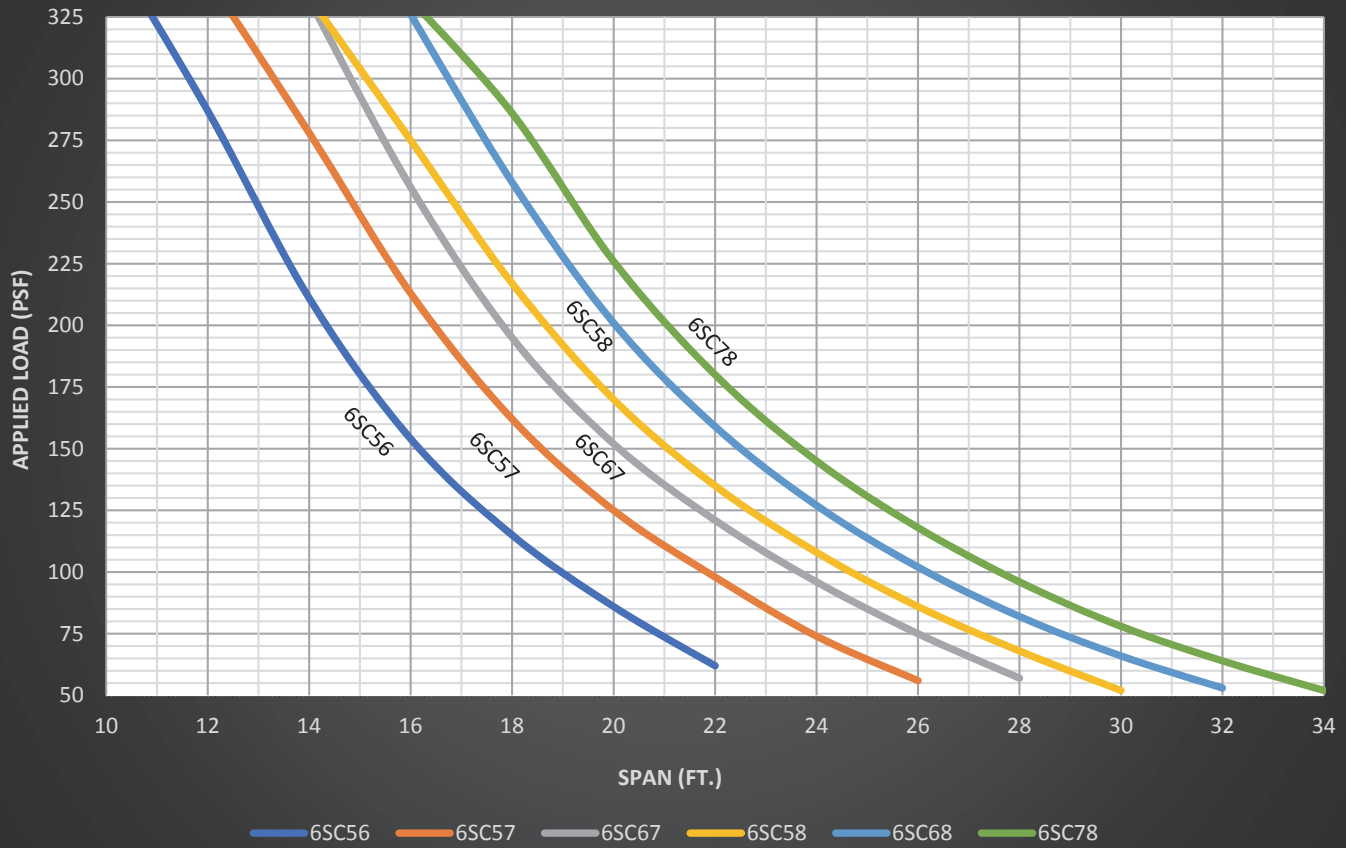

6" Composite Load Table

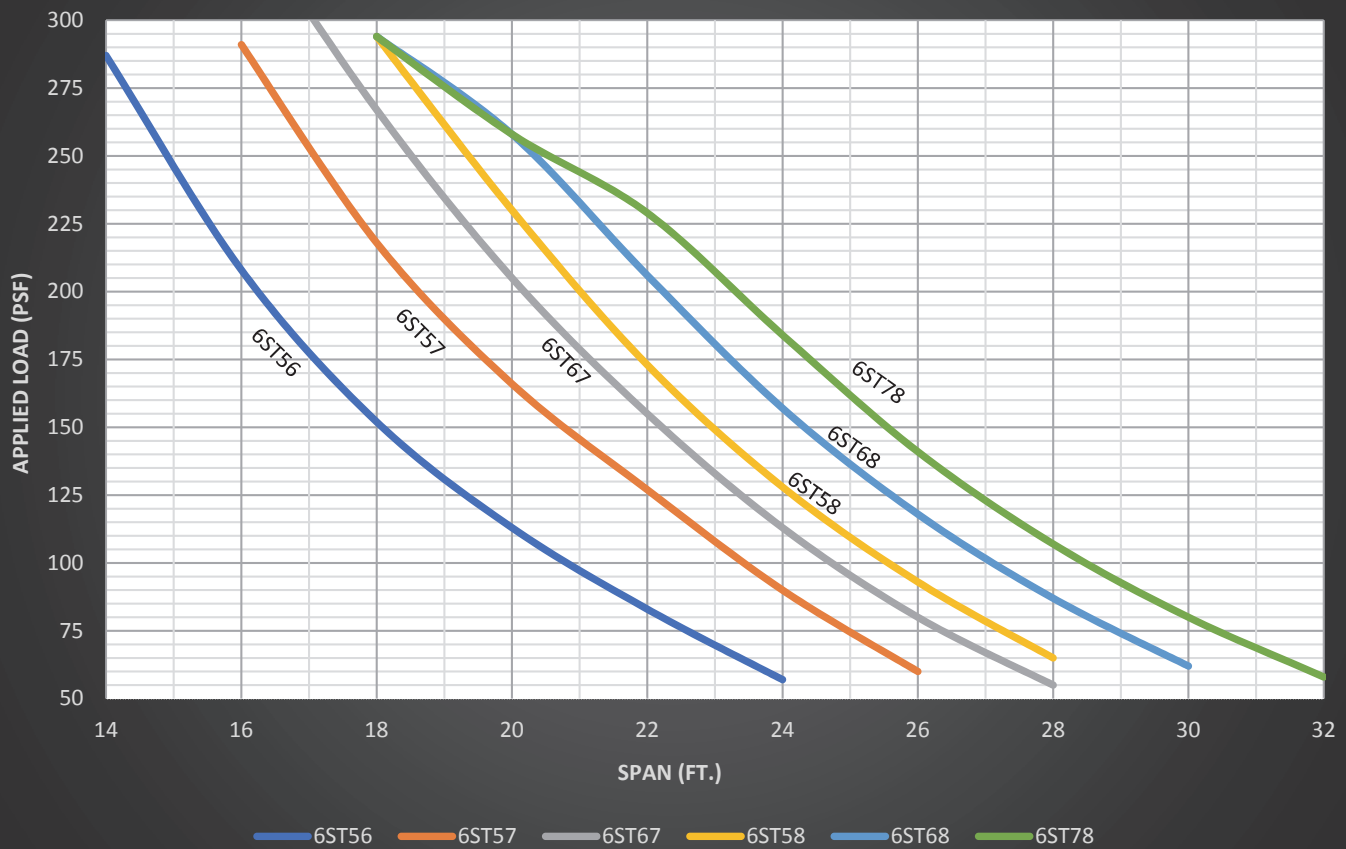

8" Non-Composite Load Table

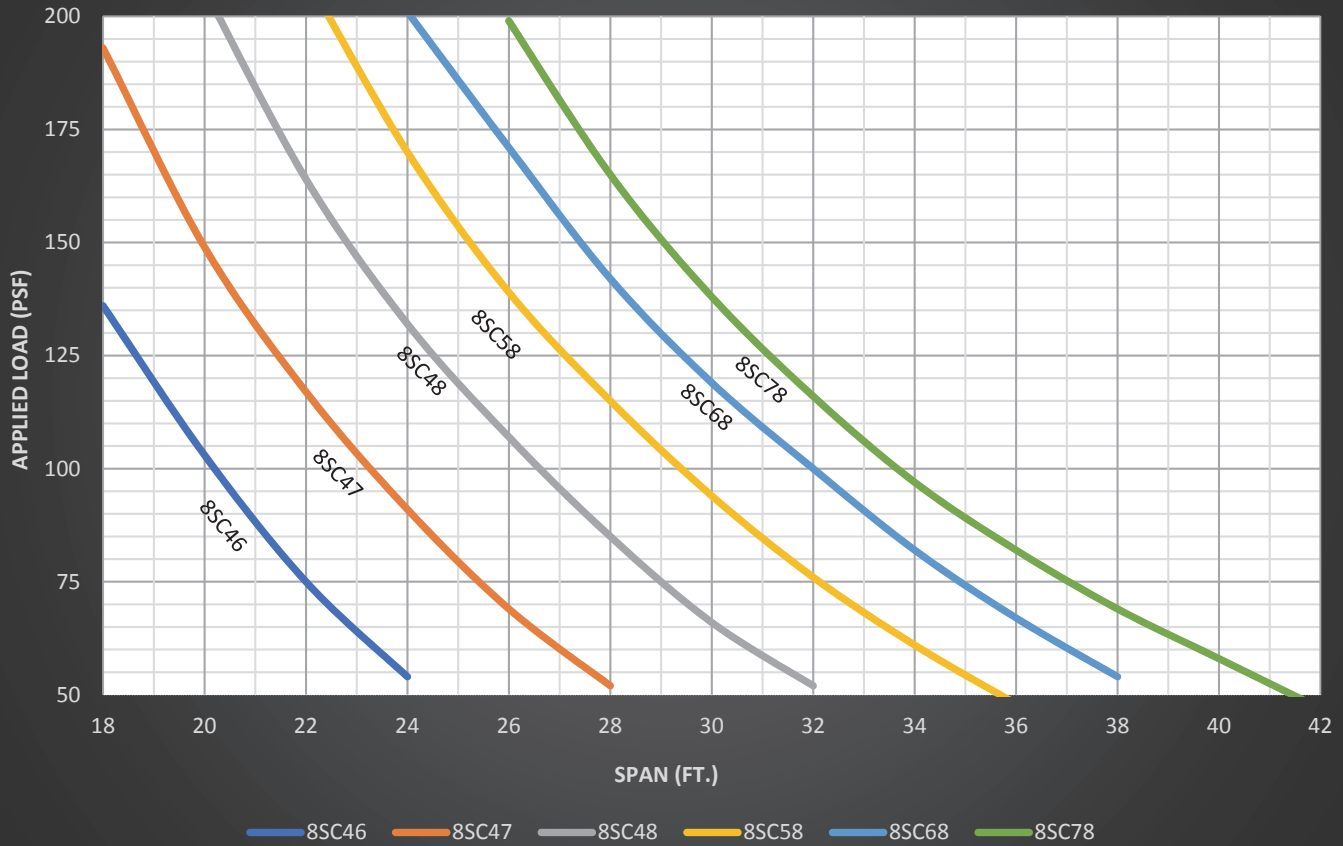

8" Composite Load Table

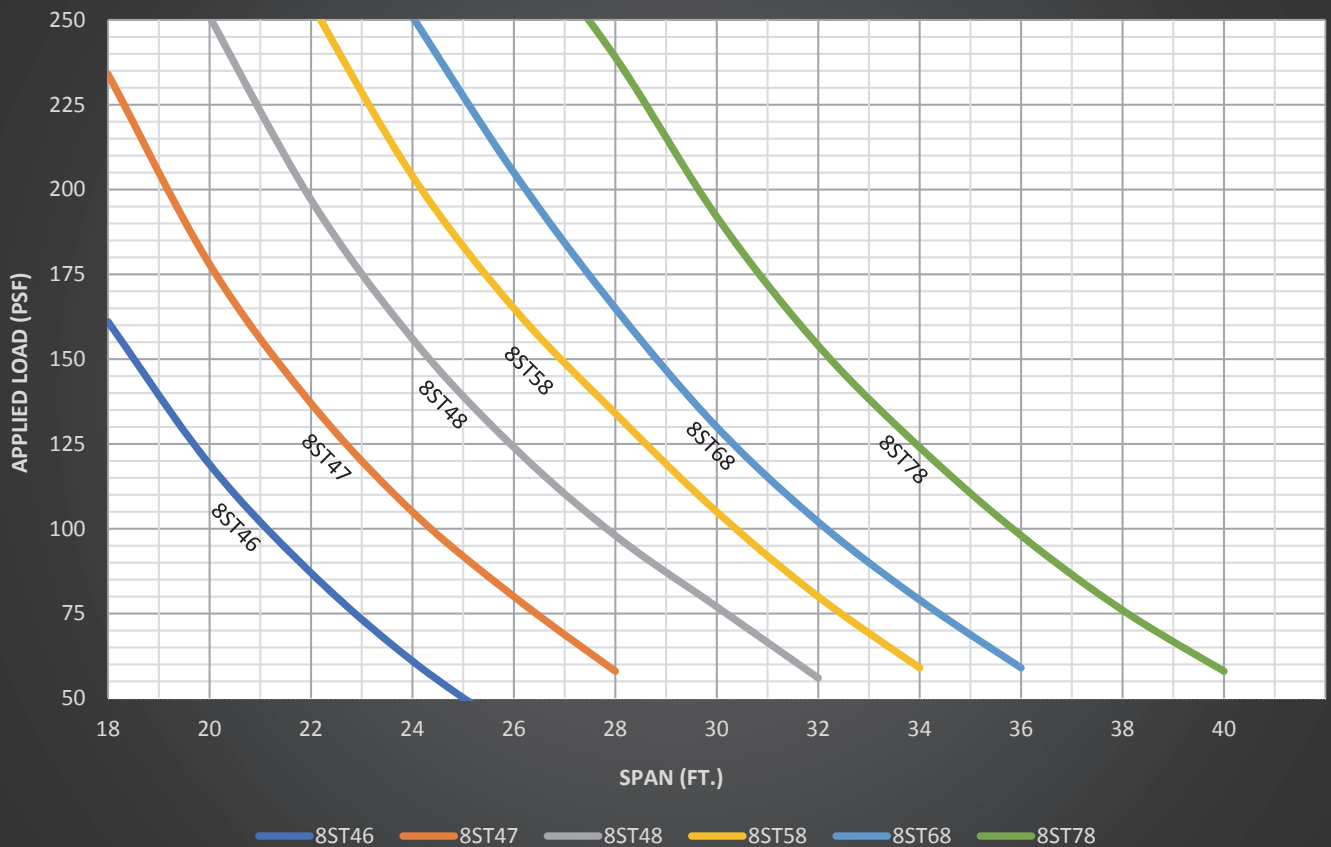

8" COREFLOOR FIGURES INDICATE SUPERIMPOSED LOADS

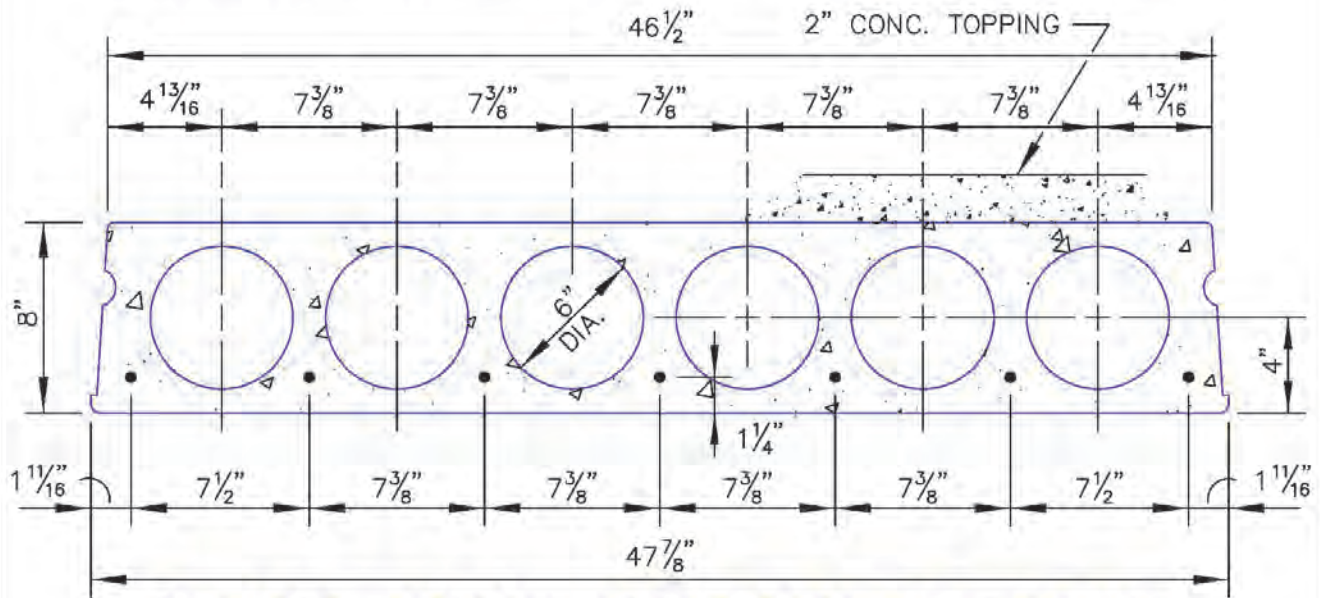

SECTION PROPERTIES

NON-COMPOSITE

$A = 214 \text{ IN.}^2$ $I = 1666 \text{ IN.}^4$
 $Y_B = 4.0 \text{ IN.}$ $WT = 56 \text{ PSF}$
 $Y_T = 4.0 \text{ IN.}$

COMPOSITE

$A = 310 \text{ IN.}^2$ $I = 3084 \text{ IN.}^4$
 $Y_B = 5.30 \text{ IN.}$ $WT = 80 \text{ PSF}$
 $Y_T = 4.70 \text{ IN.}$

SPAN IN FEET

STRAND	18'	20'	22'	24'	26'	28'	30'	32'	34'	36'	38'	40'	42'
8SC46	136	103	75	54									
8SC47	193	149	117	91	69	52							
8SC48		206	164	132	107	85	66	52					
8SC58			209	170	139	115	94	76	61	48			
8SC68				201	171	142	119	100	82	67	54		
8SC78					199	165	138	116	97	82	69	58	47
8ST46	161	119	87	61	40								
8ST47	234	178	137	105	80	58							
8ST48		251	197	156	124	98	77	56					
8ST58			255	204	165	134	105	80	59				
8ST68				251	205	165	130	102	79	59			
8ST78				279	239	192	154	124	98	76	58		

SUPERIMPOSED LOAD CAPACITY IN POUNDS PER SQUARE FOOT

* IMMEDIATE & LONG TERM DEFLECTION MAY LIMIT APPLICATION

$f_{ci} = 3500 \text{ PSI} - 4000 \text{ PSI}$

$f_c = 6500 \text{ PSI}$

STRAND = 270 KSI L.R.

CONCRETE TOPPING = 4000 PSI

SC - UNTOPPED SECTION

ST - 2" COMPOSITE TOPPING

10" Non-Composite Load Table

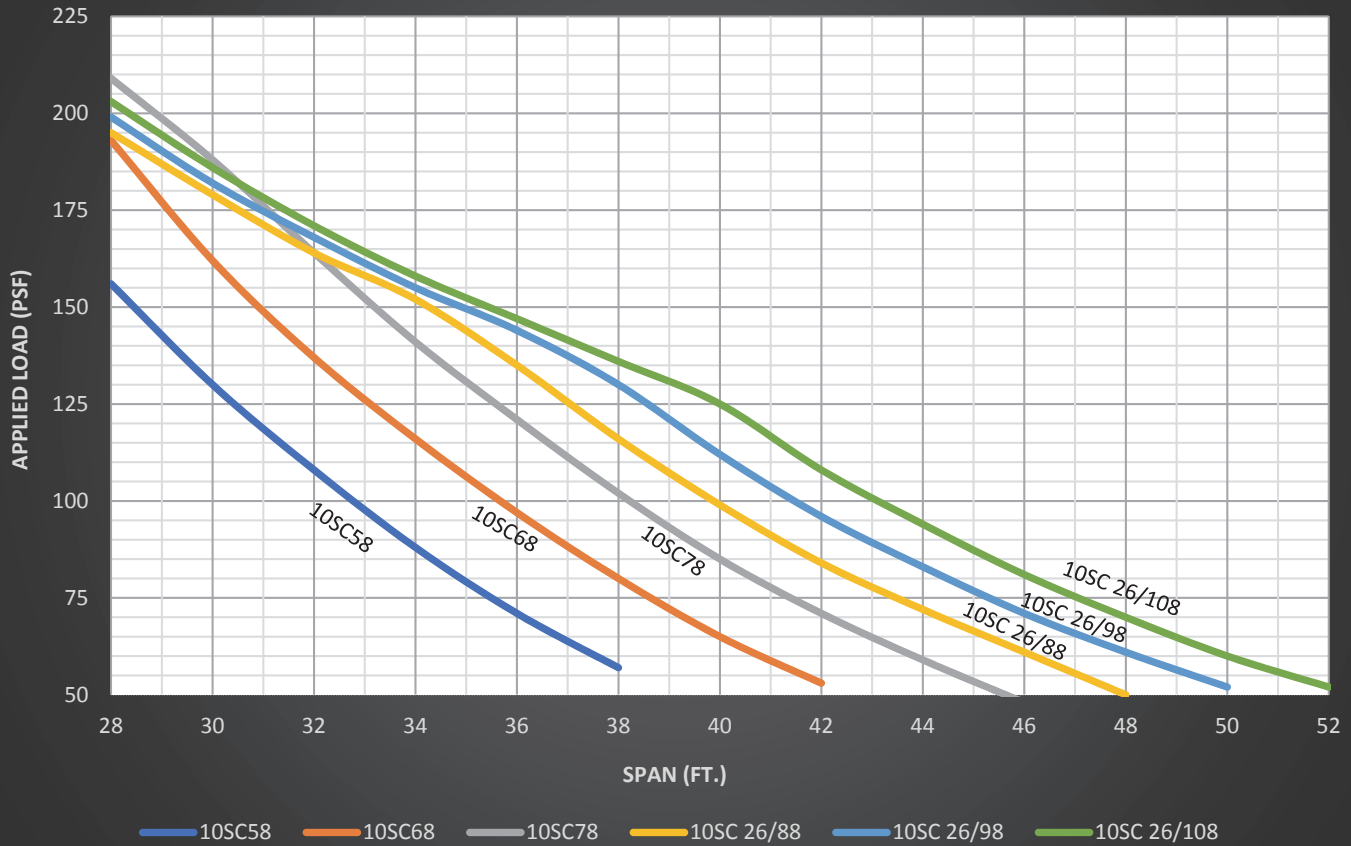

10" Composite Load Table

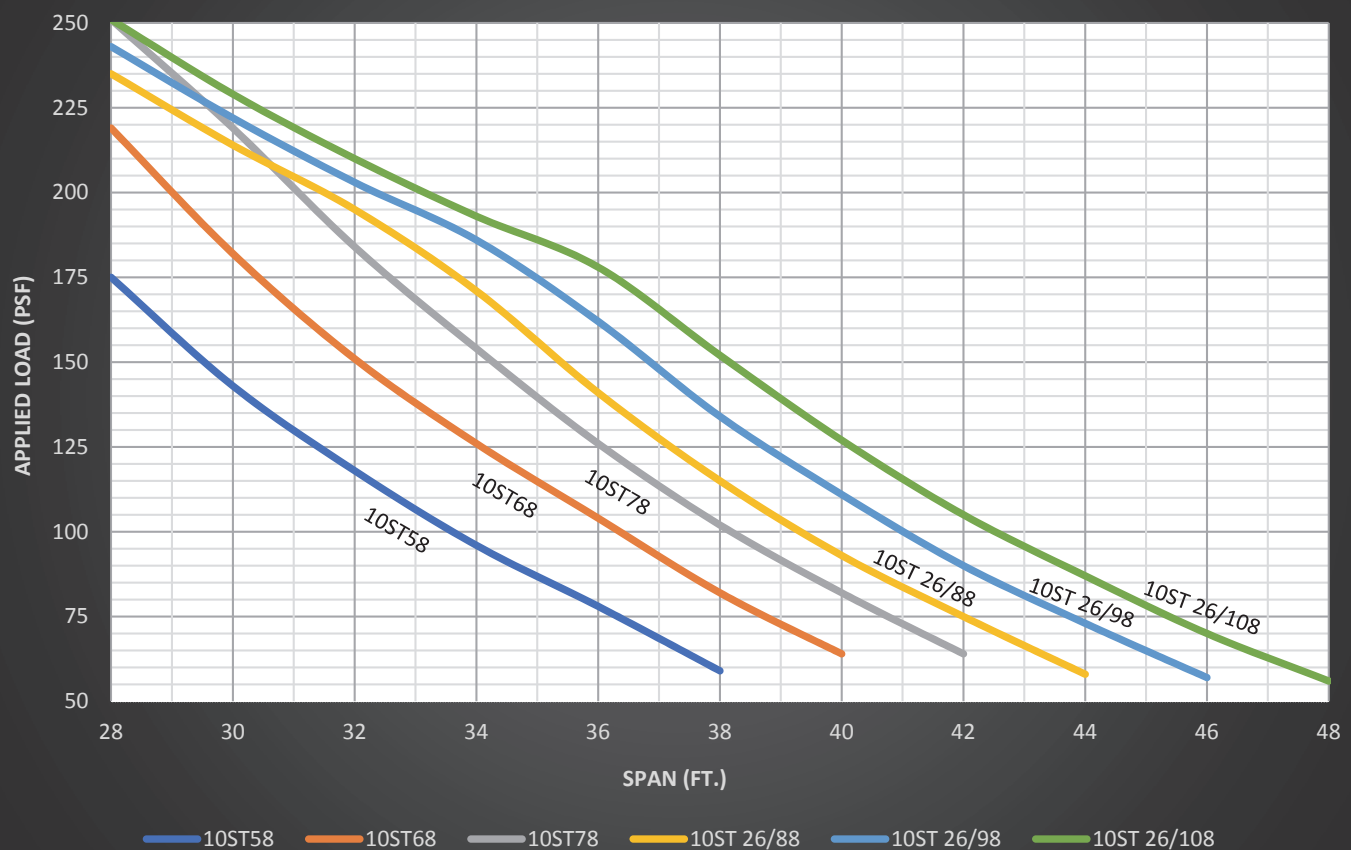

10" COREFLOOR FIGURES INDICATE SUPERIMPOSED LOADS

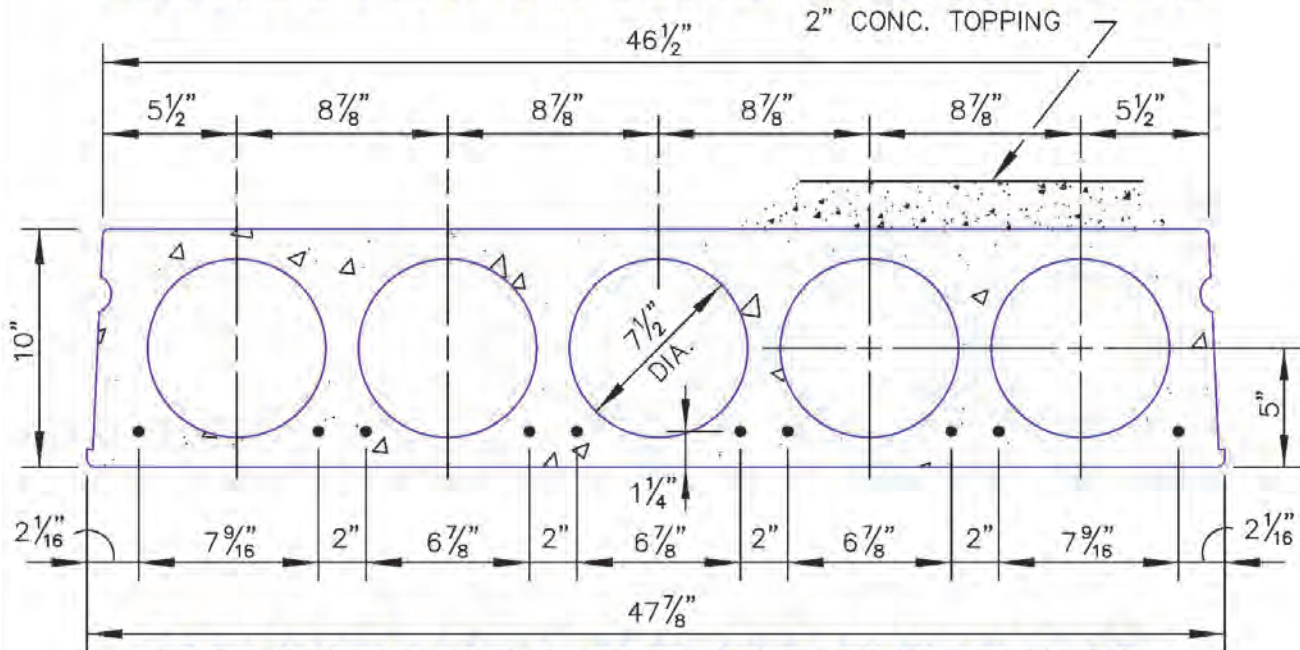

SECTION PROPERTIES

NON-COMPOSITE		COMPOSITE	
A = 259 IN. ²	I = 3223 IN. ⁴	A = 355 IN. ²	I = 5348 IN. ⁴
Y _b = 5.0 IN.	WT = 67 PSF	Y _b = 6.35 IN.	WT = 91 PSF
Y _t = 5.0 IN.		Y _t = 5.65 IN.	

SPAN IN FEET

STRAND	28'	30'	32'	34'	36'	38'	40'	42'	44'	46'	48'	50'	52'
10SC58	156	130	108	88	71	57							
10SC68	193	162	137	116	97	80	65	53					
10SC78	209	188	164	141	121	102	85	71	59	48			
10SC 26/88	195	179	164	152	135	116	99	84	72	61	50		
10SC 26/98	199	182	168	155	144	130	112	96	83	71	61	52	
10SC 26/108	203	186	171	158	147	136	125	108	94	81	70	60	52
10ST58	175	143	118	96	78	59							
10ST68	219	182	151	126	104	82	64						
10ST78	251	219	184	154	126	102	82	64					
10ST 26/88	235	214	195	171	141	115	93	75	58				
10ST 26/98	243	222	203	186	162	134	111	90	73	57			
10ST 26/108	251	229	210	193	178	152	127	105	87	70	56		

SUPERIMPOSED LOAD CAPACITY IN POUNDS PER SQUARE FOOT

* IMMEDIATE & LONG TERM DEFLECTION MAY LIMIT APPLICATION

f_{ci} = 3500 PSI-4500 PSI

f_c = 6500 PSI

STRAND = 270 KSI L.R.

CONCRETE TOPPING = 4000 PSI

SC- UNTOPPED SECTION

ST- 2" COMPOSITE TOPPING

12" Non-Composite Load Table

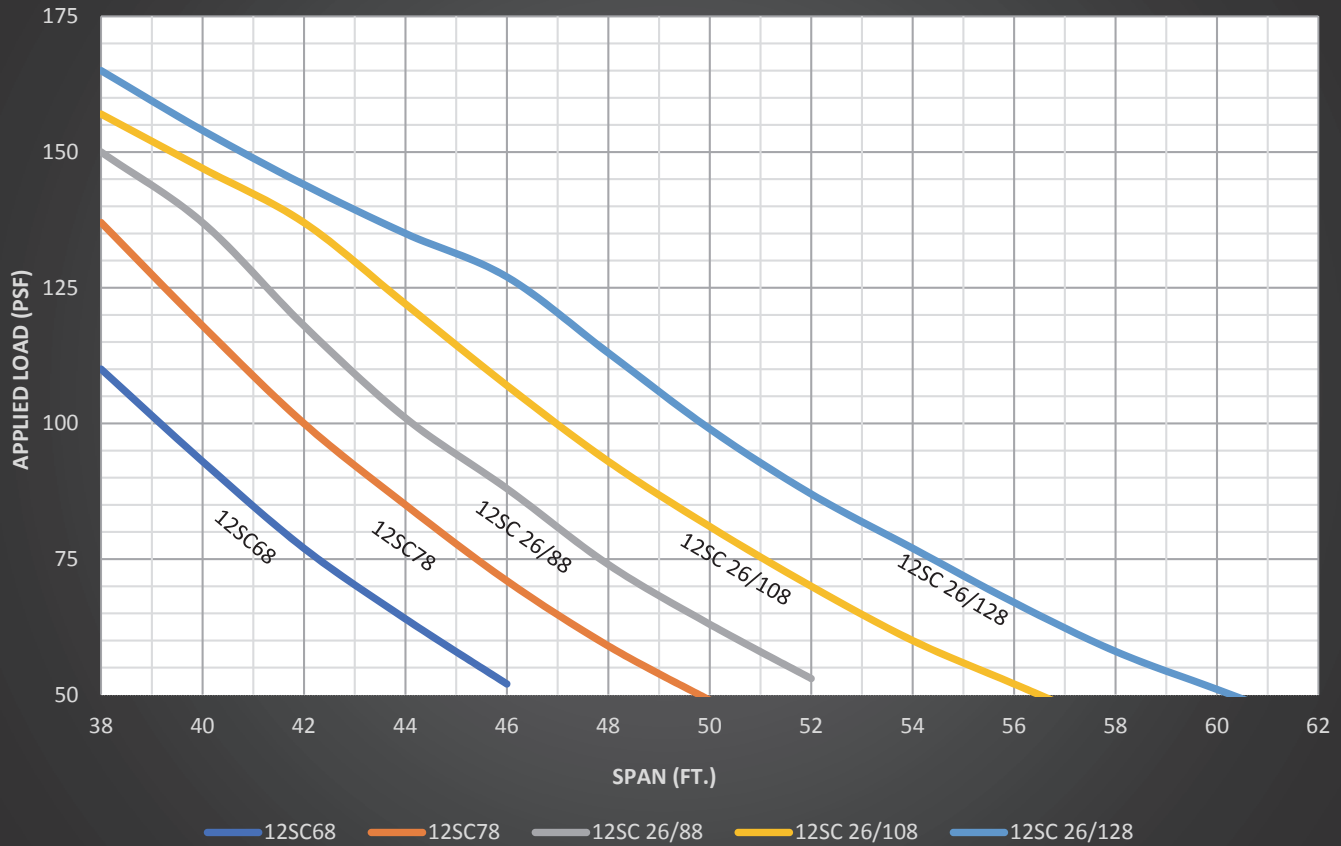

12" Composite Load Table

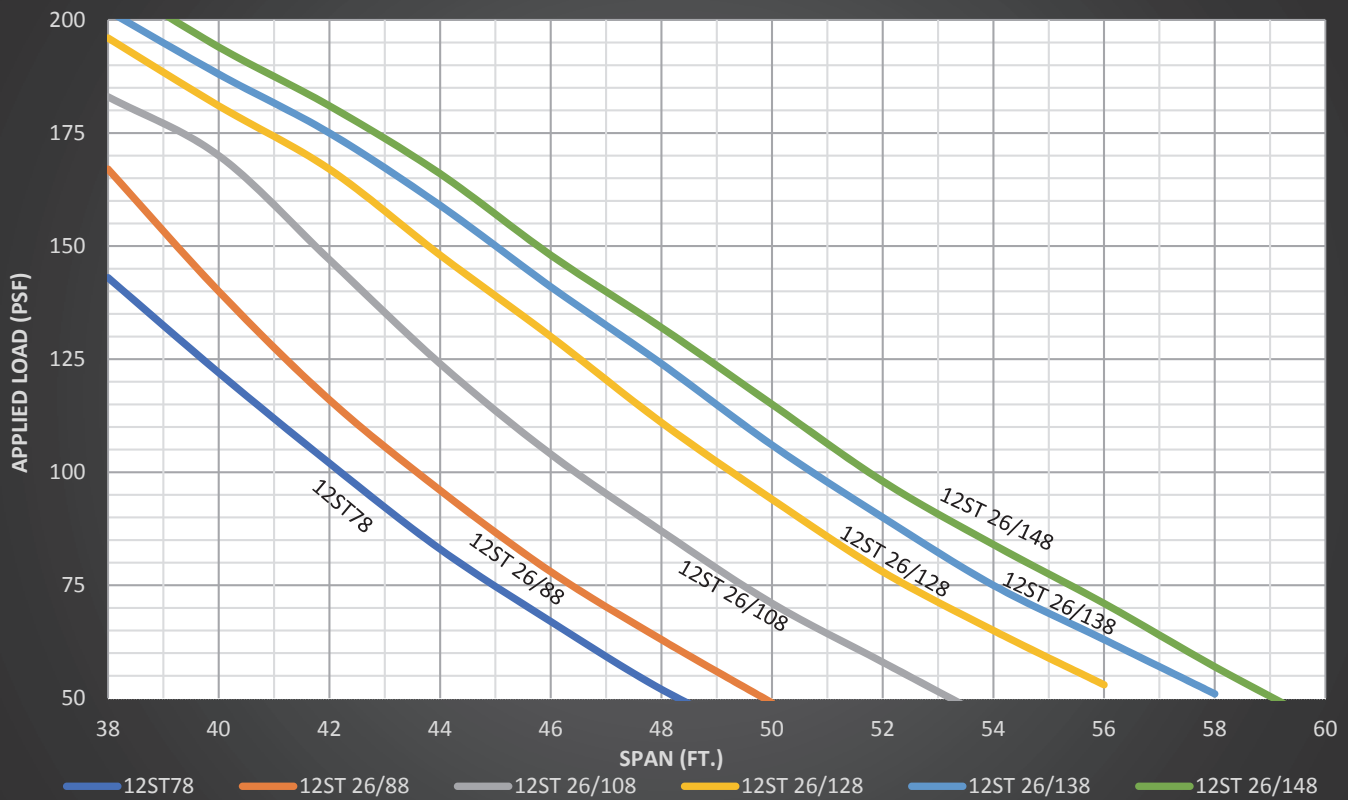

12" COREFLOOR FIGURES INDICATE SUPERIMPOSED LOADS

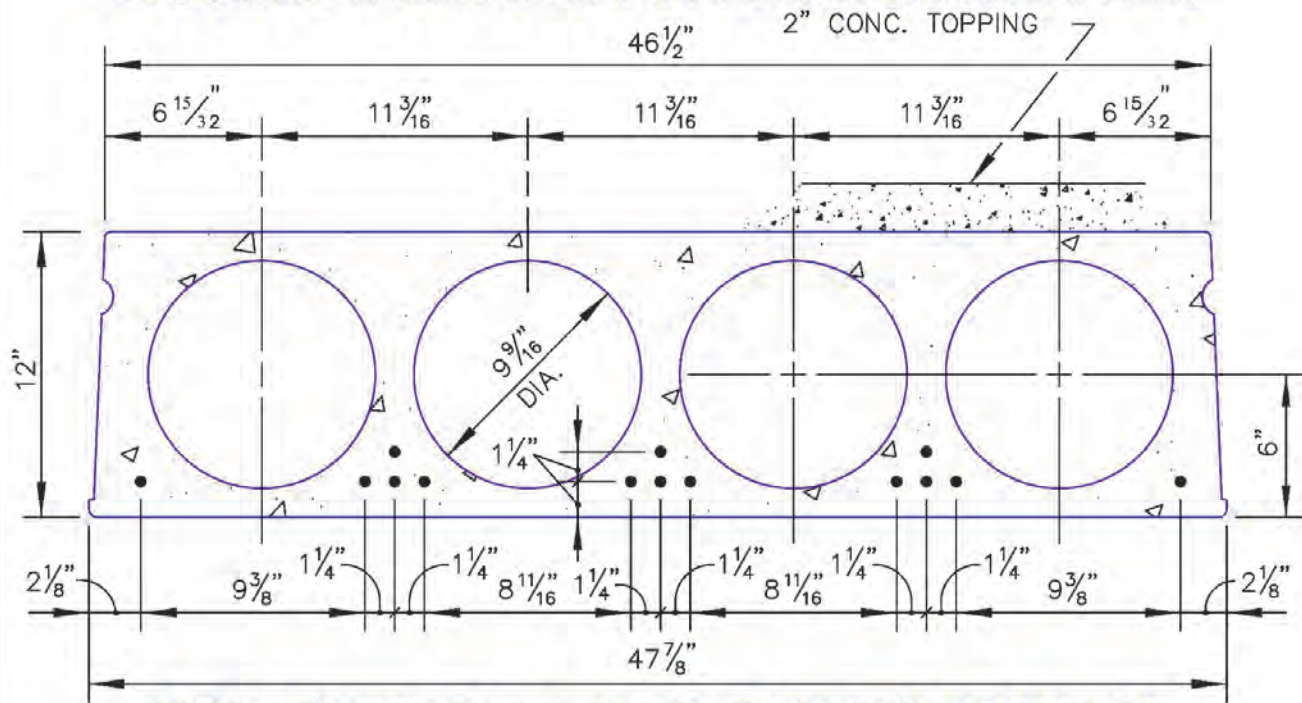

SECTION PROPERTIES

NON-COMPOSITE

A= 279 IN.² I= 5153 IN.⁴
 Y_b= 6.0 IN. WT= 73 PSF
 Y_t= 6.0 IN.

COMPOSITE

A= 375 IN.² I= 8084 IN.⁴
 Y_b= 7.49 IN. WT= 98 PSF
 Y_t= 6.51 IN.

SPAN IN FEET

STRAND	38'	40'	42'	44'	46'	48'	50'	52'	54'	56'	58'	60'	62'
12SC68	110	93	77	64	52								
12SC78	137	118	100	85	71	59	49						
12SC 26/88	150	137	118	101	88	74	63	53					
12SC 26/108	157	147	137	122	107	93	81	70	60	52	44		
12SC 26/128	165	154	144	135	127	113	99	87	77	67	58	51	44
12ST78	143	122	102	83	67	52							
12ST 26/88	167	140	116	96	78	63	49						
12ST 26/108	183	170	147	124	104	87	71	58	45				
12ST 26/128	196	181	167	148	130	111	94	78	65	53			
12ST 26/138	202	188	175	159	141	124	104	90	75	63	51		
12ST 26/148	209	194	181	166	148	132	115	98	84	71	57	44	

SUPERIMPOSED LOAD CAPACITY IN POUNDS PER SQUARE FOOT

* IMMEDIATE & LONG TERM DEFLECTION MAY LIMIT APPLICATION

f_{ci}= 3500 PSI-5500 PSI

f_c= 6500 PSI

STRAND= 270 KSI L.R.

CONCRETE TOPPING= 4000 PSI

SC- UNTOPPED SECTION

ST- 2" COMPOSITE TOPPING